



# Dolphin MXH94x / MXH95x NTB Adapter Users Guide



Version 1.4

Date: 30<sup>th</sup> November 2023



# Table of Contents

<b>DISCLAIMER</b> .....	<b>4</b>
<b>TERMS AND ACRONYMS</b> .....	<b>4</b>
<b>HIGH LEVEL SPECIFICATION</b> .....	<b>5</b>
PCIE GEN4 LINK NTB PRODUCT VARIANTS .....	5
PCIE GEN3 LINK NTB PRODUCT VARIANTS .....	5
DETAILED SPECIFICATIONS .....	5
<i>MXH94x Maximum DC current across input voltage ranges</i> .....	6
<i>MXH95x Maximum DC current across input voltage ranges</i> .....	6
MXH94X MTBF BY TEMPERATURE AND ENVIRONMENT.....	6
MXH95X MTBF BY TEMPERATURE AND ENVIRONMENT.....	7
<b>PACKAGING</b> .....	<b>8</b>
<b>PRE-INSTALLATION QUESTIONS</b> .....	<b>8</b>
PCIE SLOT DETERMINATION.....	8
ADAPTER CARD CONFIGURATION.....	8
OPERATING ENVIRONMENT.....	8
CABLE CONNECTIONS.....	8
<b>INSTALLATION</b> .....	<b>9</b>
STEP 1 - UNPACK BOARD .....	9
STEP 3 - CONFIGURE THE BOARD FOR PROPER OPERATION .....	9
STEP 4 - INSTALL THE ADAPTER CARD.....	9
STEP 5 - INSTALLING AND REMOVING CABLES .....	9
<i>Connecting Cables</i> .....	9
<i>Disconnecting Cables</i> .....	9
STEP 6 - INSTALLING THE DOLPHIN EXPRESSWARE SOFTWARE .....	9
STEP 7 – VERIFY INSTALLATION & LEDs .....	10
<b>OPERATION</b> .....	<b>11</b>
CONFIGURATION AND DIP SWITCHES.....	11
<i>DIP Switch Bank – Configuration</i> .....	11
<i>Thermal shutdown</i> .....	11
<i>DIP Switch settings for NTB operation</i> .....	11
USE CASE A - 2 NODE CONFIGURATION – NTB MODE.....	13
<i>Connecting the cables for 2 Node Configurations, x16 link</i> .....	13
USE CASE B - 3 NODE CONFIGURATION NTB MODE .....	13
<i>Connecting the cables for 3 Node Configurations, x8 link</i> .....	14
USE CASE C - 5 NODE CONFIGURATION – NTB MODE.....	14
<i>Connecting the cables for 5 Node Configurations, x4 link</i> .....	14
EEPROM AND FIRMWARE UPGRADE .....	15
IDENTIFYING THE CARD.....	15
SUPPORT .....	<b>ERROR! BOOKMARK NOT DEFINED.</b>
<b>TECHNICAL INFORMATION</b> .....	<b>17</b>
BOARD REVISION HISTORY .....	17
SIMPLIFIED SCHEMATICS .....	17
<b>COMPLIANCE AND REGULATORY TESTING</b> .....	<b>18</b>
EMC COMPLIANCE .....	18

ROHS COMPLIANCE .....	18
LASER EYE SAFETY .....	18
WEEE NOTICE .....	18
<b>LIMITED WARRANTY.....</b>	<b>19</b>
WARRANTY PERIOD.....	<b>ERROR! BOOKMARK NOT DEFINED.</b>
COVERAGE.....	<b>ERROR! BOOKMARK NOT DEFINED.</b>
SERVICE PROCEDURE .....	19

## DISCLAIMER

DOLPHIN INTERCONNECT SOLUTIONS RESERVES THE RIGHT TO MAKE CHANGES WITHOUT FURTHER NOTICE TO ANY OF ITS PRODUCTS TO IMPROVE RELIABILITY, FUNCTION, OR DESIGN.

TO THE FULLEST EXTENT PERMITTED BY LAW, DOLPHIN WILL NOT BE LIABLE FOR ANY INDIRECT, INCIDENTAL, SPECIAL OR CONSEQUENTIAL DAMAGES (INCLUDING LOST PROFITS, LOST DATA, OR LOSS OF USE) ARISING OUT OF ANY USE OF DOLPHIN'S PRODUCTS, SOFTWARE OR SERVICE PROVIDED. DOLPHIN'S MAXIMUM LIABILITY WILL NOT EXCEED THE TOTAL AMOUNT PAID FOR THE PRODUCT BY THE PURCHASER.

### LIFE SUPPORT POLICY

DOLPHIN INTERCONNECT SOLUTIONS' PRODUCTS ARE NOT AUTHORIZED FOR USE AS CRITICAL COMPONENTS IN LIFE SUPPORT DEVICES.

### ENVIRONMENTAL POLICY

Dolphin is minimizing the amount of printed documentation and software CDs in its shipments; please download additional documentation and software from [www.dolphinics.com](http://www.dolphinics.com).

## Terms and acronyms

Important terms and acronyms used in this manual

BMC	Board Management Microcontroller on the adapter card.
eXpressWare	Dolphin's software stack for PCIe clustering and IO. Please visit <a href="http://www.dolphinics.com/software">http://www.dolphinics.com/software</a> for more information.
FireFly™	Optical fiber solution for PCIe over cable from Samtec Inc
Transparent Host mode	The card is installed in a root complex / Host PC and configured for Transparent operation.
Transparent Hot Add	Attaching an IO Expansion system after the server is booted.
Target mode	The card is installed in an expansion chassis or backplane for Transparent IO expansion.
Lane reception.	One PCI Express Lane contains a differential pair for transmission and a differential pair for
Link	A collection of one or more PCI Express Lanes providing the communication path between an Upstream and Downstream Port.
NTB mode	The card is configured for Non Transparent Bridge operations. Requires Dolphin eXpressWare or custom NTB drivers.
Port	PCIe Cable port. The adapter card, depending on the model, has up four x4 ports, named L0, L1, L2, L3. The physical ports are identified by text on the PCIe brackets.

## High Level Specification

The MXH94x and MXH95x are a family of low profile, half-length PCIe adapters utilizing the Samtec FireFly™ optical transceivers. It is available in several variants to support various use cases and configurations. All boards are using a Gen4 PCIe switch from Microchip. The MXH94x boards are equipped with Samtec FireFly™ PCIe Gen4 optical transceivers. The MXH95x boards are equipped with the Samtec FireFly™ PCIe Gen3 optical transceivers.

Some of these variants come with NTB enabled firmware and are bundled with Dolphins eXpressWare. Please reference the tables below for details. This manual covers all NTB enabled variants. Please reference the Dolphin MXH94x / MXH95x Transparent Adapter Users Guide if you have one of the Transparent only variants.

The cards operate at the highest common speed shared between the slot and the card (Gen4) and the widest common link-width (x16).

## PCIe Gen4 Link NTB Product variants

The variants in the table below utilize Gen4 FireFly™ modules, support NTB configurations and come with a full eXpressWare software license. Each Model has different FireFly™ optical engines mounted depending on your use case and requirements:

SKU / Model	#FireFly™	Config	Required Fiber cable
MXH940	2 x8	NTB x16 / NTB 2 x8	2 units 24 fiber MPO
MXH941	1 x8	NTB x8	1 unit 24 fiber MPO
MXH943	2 x4	NTB x8 / NTB 2 x4	2 units 12 fiber MPO
MXH944	1 x4	NTB x4	1 unit 12 fiber MPO
MXH949	4 x4	NTB x16, NTB 2 x8, NTB 4x 4	4 units 12 fiber MPO

**NOTE:** Please note that cards utilizing 24 fiber MPO cannot be connected to cards utilizing 12 fiber MPO.

## PCIe Gen3 Link NTB Product variants

The variants in the table below utilize the Gen3 FireFly™ modules, support NTB configurations and come with a full eXpressWare software license. Each Model has different FireFly™ optical engines mounted depending on your use case and requirements:

SKU / Model	#FireFly™	Config	Required Fiber cable
MXH950	2 x8	NTB x16 / NTB 2 x8	2 units 24 fiber MPO
MXH951	1 x8	NTB x8	1 unit 24 fiber MPO
MXH953	2 x4	NTB x8 / NTB 2 x4	2 units 12 fiber MPO
MXH954	1 x4	NTB x4	1 unit 12 fiber MPO
MXH959	4 x4	NTB x16, NTB 2 x8, NTB 4x 4	4 units 12 fiber MPO

**NOTE:** Please note that cards utilizing 24 fiber MPO cannot be connected to cards utilizing 12 fiber MPO.

## Detailed specifications

- PCI Express Base Specification, Rev. 4.0.
- PCI Express CEM Specification, Rev. 4.0.
- PCI Express Gen4 16.0 GT/s per lane signaling – 256 GT/s total signaling. Variants utilizing Gen3 FireFly™ modules are limited to PCIe Gen3 8 GT/S signaling rate on the optical link.
- PCI Express Gen4 x16 edge connector. The card installs in any PCI Express slot that has a physical x16 connector.
- Compliant with PCI Express Gen1 through Gen4 computers and IO systems, auto detection.
- Cable port configurations (depends on SKU number)
  - One x16 NTB port
  - Two x8 NTB ports
  - Four x4 NTB ports
  - One x8 NTB port
  - Two x4 NTB ports
  - One x4 NTB port
- MPO cable connector
- Microchip / Microsemi Switchtec™ PM40036B PFX PCI Express Gen4 chipset. (PM40052B used in Rev A and B cards)

- Pre-loaded firmware configurations, DIP switch selectable. Please reference the adapter card firmware release note for details.
- 100 nanosecond cut-through latency port to port.
- PCIe DMA engine for optimized transfers.
- Support for optical patch cables up to 100 meters.
- Low profile, Half-length - PCI Express Electromechanical Specification, Rev 4.0.
- Dimensions 167.65mm (6.600 inches) x 68.90 mm (2.731 inches).
- Host clock isolation. Automatic support for host running CFC or SSC mode.
- VAUX powered board management controllers for flexible configuration and cable management.
- Flash recovery option. PFX Multi configuration support.
- Operating Temperature: 0°C - 55°C (32°F - 131°F), Air Flow: 600 LFM
- Relative Humidity: 5% - 95% (non- condensing)
- CE and FCC markings
- One year warranty

### MXH94x Maximum DC current across input voltage ranges

MXH94X			
#FireFly™	12V	3.3V	VAUX
1	1.97 A	0.84 A	0.35 A
2	2.30 A	0.84 A	0.35 A
3	2.62 A	0.84 A	0.35 A
4	2.95 A	0.84 A	0.35 A

### MXH95x Maximum DC current across input voltage ranges

MXH95X			
#FireFly™	12V	3.3V	VAUX
1	1.76 A	0.84 A	0.35 A
2	1.88 A	0.84 A	0.35 A
3	2.00 A	0.84 A	0.35 A
4	2.12 A	0.84 A	0.35 A

Note:

25 W Slot specification for +12V rail is 2.1 A max.

75 W slot specification for +12 V rail is 5.5 A max.

### MXH94x MTBF by Temperature and Environment

The MTBF (in hours) for the MXH94x with 1, 2 or 4 Gen4 FireFly modules mounted can be found in the table below. The numbers are calculated using the Telcordia SR-332 issue 2 (2006) standard.

Ambient Temp. [°C]	MXH94x 1 FireFly mounted	MXH94x 2 FireFly mounted	MXH94x 4 FireFly mounted
0	3.695.205	3.043.158	2.249.339
5	3.085.401	2.497.241	1.807.952
10	2.555.388	2.037.075	1.449.193
15	2.100.911	1.653.639	1.159.806
20	1.716.081	1.337.251	927.674
25	1.393.934	1.078.290	742.173
30	1.126.968	867.705	594.276
35	907.657	697.322	476.485
40	728.823	559.986	382.683
45	583.891	449.592	307.936
50	467.021	361.019	248.302
55	373.156	290.036	200.648

Table 1: MXH94x MTBF vs. Temperature for Ground Fixed, Controlled (GB) Environment

## MXH95x MTBF by Temperature and Environment

The MTBF (in hours) for the MXH95x with 1, 2 or 4 Gen3 FireFly modules mounted can be found in the table below. The numbers are calculated using the Telcordia SR-332 issue 2 (2006) standard.

Ambient Temp. [°C]	MXH95x 1 FireFly mounted	MXH95x 2 FireFly mounted	MXH95x 4 FireFly mounted
0	3.695.205	3.043.158	2.249.339
5	3.085.401	2.497.241	1.807.952
10	2.555.388	2.037.075	1.449.193
15	2.100.911	1.653.639	1.159.806
20	1.716.081	1.337.251	927.674
25	1.393.934	1.078.290	742.173
30	1.126.968	867.705	594.276
35	907.657	697.322	476.485
40	728.823	559.986	382.683
45	583.891	449.592	307.936
50	467.021	361.019	248.302
55	373.156	290.036	200.648

**Table 2: MXH95x MTBF vs. Temperature for Ground Fixed, Controlled (GB) Environment**

## Packaging

The products are delivered includes the following components.

- Adapter Board with pre mounted FireFly™ modules and standard profile bracket.
- Anti-static bag
- Getting started guide with serial number for quick download of Dolphins PCIe software.

## Pre-Installation Questions

Certain steps should be taken prior to installing the adapter card. You should determine the following configuration requirements.

- Which PCIe slot in the system will the card be installed?
- What is the speed and link width of the installation slot?
- What is the operating environment around the installed card?
- What quantity, type, and length of patch cable will be used?
- Are the operational conditions proper - temperature and airflow?

## PCIe Slot Determination

The adapter card supports PCIe Gen1, Gen2, Gen3 and Gen4 speeds. The adapter card must be installed in physical x16 connector but supports x1, x2, x4, x8 and x16 electrical slot-widths. The slot width and speed will affect the performance of the adapter card. The adapter card will auto configure to the slot speed and width.

**NOTE:**

- Install the adapter card in a slot connecting directly to the CPU for optimal shared memory performance.
- Install the adapter card behind a PCIe switch in the IO system for optimal PCIe peer to peer performance (e.g. between GPUs, FPGAs).

**TIP:** After installing the eXpressWare software, run the "sisci\_benchmarks" benchmark suite to verify the expected performance. Please contact Dolphin support if you need assistance to reach the expected performance.

## Adapter card Configuration

The adapter card has a DIP switch bank to control the main configuration of the card. The DIP switch labeled SW1 can be found close to the upper edge of the board. The default DIP switch setting is NTB Host operation, single, full width link operations.

## Operating Environment

To maximize lifespan for the product and maintain the warranty, please honor the specified operating temperature, and make sure the specified air flow is present. Special care should be considered when the adapter card is used in office type cabinets in combination with other high energy consuming PCIe devices, e.g. not active cooled GPUs:

Operating Temperature: 0°C - 55°C (32°F - 131°F), Airflow: 600 LFM  
Relative Humidity: 5% - 95% (non- condensing)

**TIP:** After installing the Dolphin eXpressWare software, you can use the tool dis\_diag to determine the actual adapter card temperatures (PCIe switch, FireFly™ etc.).

**NOTE:** The adapter card includes an overtemperature overheat protection. The BMC will automatically shut down the card if a PCIe switch temperature beyond 105°C (221°F) or a FireFly temperature beyond 70 °C (158°F) is detected. The automatic shutdown can be disabled by setting DIP-Switch OPT6.

**NOTE:** The adapter card link LEDs will start flashing yellow when a PCIe switch temperature of 95°C (203°F) is reached or when FireFly reports a temperature of 60°C (14°F).

## Cable Connections

The adapter cards are designed for 12 or 24 fiber MPO optical patch cables. Please carefully select the 12 or 24 fiber path cables specified for each product variant.

**NOTE:** Please note that all cards utilizing 24 fiber MPO cannot be connected to cards utilizing 12 fiber MPO.



# Installation

## Step 1 - Unpack board

The adapter card is shipped in an anti-static bag to prevent static electricity damage. The card should only be removed from the bag after ensuring that anti-static precautions are taken. Static electricity from your clothes or work environment can damage your PCI Express adapter card or your PC. Always wear a grounded anti-static wrist strap while opening the PC and when the adapter card is removed from the anti-static bag.



Unpack the adapter card from the anti-static bag using proper anti-static procedures.

## Step 3 - Configure the Board for Proper Operation

Set the DIP switch settings for proper operation depends on the firmware. Please refer to the section Configuration and DIP Switches on page 11 for details.

## Step 4 - Install the Adapter Card

Before installing the adapter card, make sure you are properly grounded to avoid static discharges that may destroy your computer or the adapter card. Ensure you are properly grounded before opening your computer or the anti-static bag containing the adapter card. Please follow your computer's or expansion chassis' manual on how to install a PCI Express card.



The adapter card can only be installed into any PCI Express x16 physical slot. The adapter supports PCI Express Gen1, Gen2, Gen3 and Gen4 signaling. The adapter supports hosts using either spread spectrum or constant frequency clocking. The card implements clock isolation.

## Step 5 - Installing and Removing Cables

Installing and removing cables in NTB or Transparent Hot Add mode can be done while the systems are running. Hot plugging / removing cables are fully supported. The fiber optic cable(s) are connected to the MPO connector(s) found on the PCIe bracket. The bracket will have one or two, single or dual MPO connectors depending on the board configuration.

### Connecting Cables

Please carefully install the fiber patch cable connector into the connector housing on the adapter card. To install the cable, remove the protective cover on both the cable and the card, match the cable house keying with the MPO connector on the adapter card and use light pressure to insert the connector until it is latched. Cables should always use strain relief to protect the connected equipment from excessive force on the cable. This is especially important for cables between racks. Please always save the protective covers for future use if the cable is disconnected from the card.

### Disconnecting Cables

Please carefully pull the release tab to release the cable from the locking. Always replace the protective cover on both the card and the cable after disconnecting the cable.

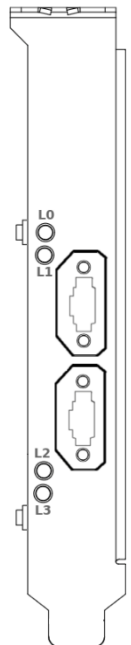

## Step 6 - Installing the Dolphin eXpressWare Software

The adapter card is compliant with Dolphin's eXpressWare software package for the MX product line. Please visit

<https://www.dolphinics.com/mx>

to register and download the latest documentation and software. It is recommended to follow the quick installation guide found on the web page above to install the software for your operating system.

### Note to PXH84x users:

If you are migrating from any of the PCIe Gen3 PXH84x adapter cards to the MXH94x or MXH95x cards, you need to uninstall the PX software and install the MX software.

**TIP:** Dolphin provides software and documentation for several product families; **please remember to select the MX product family before downloading.** The adapter card requires Dolphin software version DIS 5.18.0 or higher to operate. The software download requires a password to log in. **The password will automatically be emailed to you if you follow the instructions found on the getting started document bundled with the adapter card.** If you fail to provide the correct serial number found on the getting started document, your request will be managed manually.

## Step 7 – Verify Installation & LEDs

The adapter card comes with 4 bi-color LEDs which show the corresponding cable port status according to Table 3: LED below.

The LEDs are visible through cut-outs in the PCIe bracket on each side of the cable connector block.

LED color	Function
Off	No cable installed
Yellow	Cable installed, no link
Yellow blink	Link reset
Green	Cable installed; link operational
Blinking green	Link operating at lower speed
Blinking yellow	Temperature overheat warning, please immediately improve cooling to avoid thermal damages or system shutdown.

**Table 3: LED behavior**

# Operation

## Configuration and DIP Switches

The adapter card has one bank of 8 DIP switches for setting special modes or operations, the meaning of each DIP switch depends on the loaded firmware. Please carefully read the documentation shipping with the card before modifying any DIP switch settings. Please pay close attention to ON and OFF positions written on the DIP switch.

The default factory setting for the NTB enabled adapter cards is a single NTB link connection suitable for a two-node configuration.

### DIP Switch Bank – Configuration

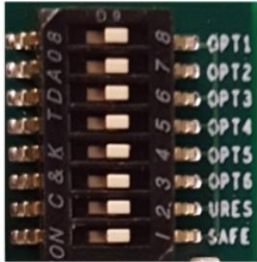

Figure 1: DIP Switch shows the configuration DIP switch for the adapter card. Please leave all undocumented DIP switches in the default position. Table 4: DIP Switch settings shows all the various DIP switch NTB settings for the adapter card.

Figure 1: DIP Switch

DIP no.	Name	Description	ON	OFF	Default
1-5	OPT1-5	Configuration selector, details below			Opt4: ON
6	OPT6	Thermal Shutdown Disable.	Will disable thermal shutdown	Card will shut down on thermal overheat	OFF
7	MCU Reset	Holds the management processors in reset	Board management is held in reset	Normal operation	OFF
8	Recover	Enables the card to recover if the FLASH has been corrupted. Do NOT ACTIVATE without instructions from Dolphin.	Do not activate without instructions from Dolphin	Normal operation	Recover

Table 4: DIP Switch settings

Note: DIP switch configuration options may be changed in the future versions. Please always consult the latest version of this guide for details.

### Thermal shutdown

The adapter card includes an overtemperature overheat protection. The BMC will automatically shut down the card if a PCIe switch temperature beyond 105°C (221°F) or a FireFly temperature beyond 70 °C (158°F) is detected. The automatic shutdown can be disabled by setting DIP-Switch OPT6.

**NOTE:** The adapter card link LEDs will start flashing yellow when a PCIe switch temperature of 95°C (203°F) is reached or when FireFly reports a temperature of 60°C (14°F).







**NOTE:** The automatic shutdown can be disabled by setting DIP-Switch OPT6. Prior to disabling the automatic shutdown, please ensure you have established proper airflow.

## NTB Operation

The default configuration is NTB operation.

### DIP Switch settings for NTB operation

The following DIP Switch settings should be considered when configuring the adapter card for NTB operation:

MXH930 DIP settings	DIP switch view – 256MB BAR	32GB BAR Option <i>All systems may not support this.</i>
<p><b>Single x16 port</b></p>	 <p><i>(Shipping Default, Opt 4 set)</i></p>	 <p><i>(Opt 1 and 4 set)</i></p>
<p><b>Dual x8 ports</b> (Note 1)</p>	 <p><i>(Opt 2 and 4 set)</i></p>	 <p><i>(Opt 1, 2 and 4 set)</i></p>
<p><b>Quad x4 ports</b> (note 1)</p>	 <p><i>(Opt 3 and 4 set)</i></p>	 <p><i>(Opt 1, 3 and 4 set)</i></p>

Note 1) These options require PFX Flash version 10 or higher. Please consult the firmware release note for details.

## NTB Use Cases Summary and DIP Settings

The adapter card may be used in the following NTB use cases. Please contact Dolphin if you have other requirements for BAR size.

Use case	Description	BAR SIZE	DIP switch setting
A	Two node NTB configuration. Both systems have the same type of adapter card installed	256 Megabytes	Opt4: ON
		32 Gigabytes	Opt4: ON Opt1: ON
B	Three node NTB configuration. All systems have the same type of adapter card installed	256 Megabytes	Opt4: ON Opt2: ON
		32 Gigabytes	Opt4: ON Opt2: ON Opt1: ON
C	Five node NTB configuration. All systems have the same type of adapter card installed	256 Megabytes	Opt4: ON Opt3: ON
		32 Gigabytes	Opt4: ON Opt3: ON Opt1: ON

Table 5: Use Case DIP switch settings

### Use Case A - 2 Node Configuration – NTB Mode

Each node has an NTB enabled adapter card and a direct cable connection to the other system. This configuration is fully supported by all Dolphin software, from version DIS 5.18.0 and newer. Both adapter cards operate in NTB mode. Dip switches should be set as specified in Table 4: DIP Switch settings on page 11.

Connecting the cables for 2 Node Configurations, x16 link

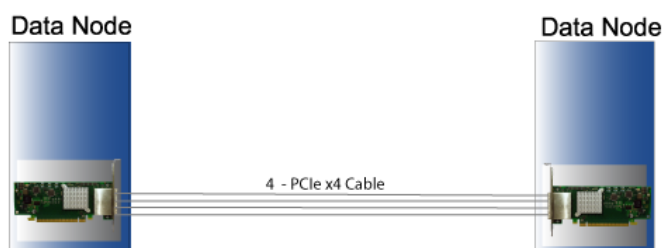

To establish an x16 link, a given port number should be connected to the same port number on the other card.

### Use Case B - 3 Node Configuration NTB Mode

Each node has a MXH940 or MXH950 adapter installed, and a direct x8 cable connection is used between all systems. This configuration is fully supported by all Dolphin eXpressWare, version DIS 5.19.2 and newer. All adapter cards operate in NTB mode. Dip switches should be set as specified in Table 4: DIP Switch settings on page 11.

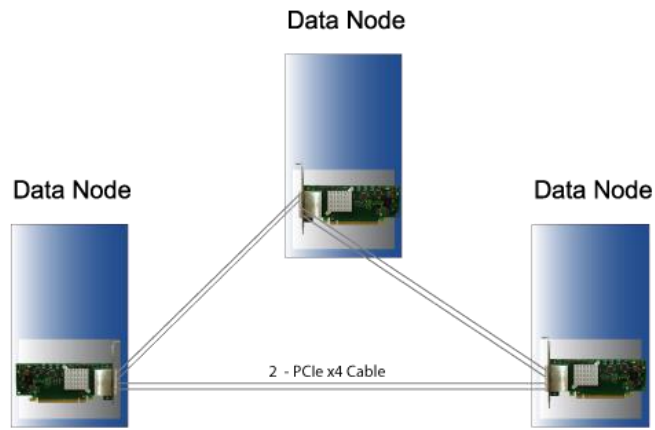

### Connecting the cables for 3 Node Configurations, x8 link

Connect the cables between two nodes as described above, connecting two nodes x8. Connect the third node to the two other cards using similar rules. Always connect P1 + P2 to P1 + P2 or P3 + P4

## Use Case C - 5 Node Configuration – NTB Mode

Each node has a MXH930 adapter and a direct x4 cable connection is used between all systems. This configuration is fully supported by all Dolphin software, from version DIS 6.0.0 and newer. All MXH930 adapter cards operate in NTB mode. Dip switches should be set as specified in Table 4: DIP Switch settings on page 11.

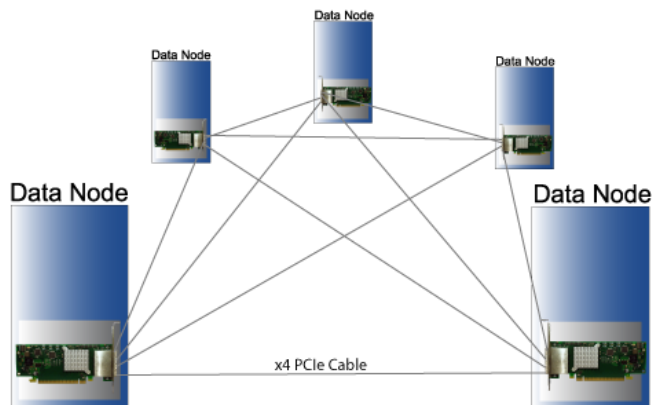

### Connecting the cables for 5 Node Configurations, x4 link

Connect any cable/port to any port on the remote system ensuring there is a single x4 cable directly between all nodes.

## EEPROM and Firmware Upgrade

Dolphin may from time to time publish updated firmware for the Board Management Controller, PCIe switch or EEPROM data for the card. Please contact Dolphin for instructions on how to upgrade the adapter card

**WARNING:** Please note that standard Microsemi tools (ChipLink) cannot be used to upgrade the firmware as this will violate the warranty. Please contact Dolphin for instructions on how to upgrade the adapter card firmware.

**Note:** Please consult the adapter card firmware release note for details on supported configurations.

## Identifying the Card

The card has a label-sticker with the serial number in the format 'MXH940-YY-ZZZZZ', where YY denotes the card revision (e.g. CC) and ZZZZZ denotes the serialized production number (e.g. 012345) – this whole string makes up the serial number of the card (i.e. MXH940-CC-012345).

You can also get this information using `lspci` in Linux:

First, identify the devices for the Dolphin Host card:

```
# lspci | grep "Device 4036"

09:00.0 PCI bridge: PMC-Sierra Inc. Device 4036
09:00.1 Bridge: PMC-Sierra Inc. Device 4036
0a:00.0 PCI bridge: PMC-Sierra Inc. Device 4036
```

Then run `lspci` and identify the card. It will show up as something like

```
# # lspci -s 9:0.0 -v

09:00.0 PCI bridge: PMC-Sierra Inc. Device 4036 (prog-if 00 [Normal decode])
    Control: I/O+ Mem+ BusMaster+ SpecCycle- MemWINV- VGASnoop- ParErr- Stepping- SERR- FastB2B-
    DisINTx+
    Status: Cap+ 66MHz- UDF- FastB2B- ParErr- DEVSEL=fast >TAbort- <TAbort- <MAbort- >SERR-
    <PERR- INTx-
    Latency: 0
    Interrupt: pin ? routed to IRQ 34
    Bus: primary=09, secondary=0a, subordinate=0b, sec-latency=0
    I/O behind bridge: 00001000-00001fff
    Secondary status: 66MHz- FastB2B- ParErr- DEVSEL=fast >TAbort- <TAbort- <MAbort- <SERR- <PERR-
    BridgeCtl: Parity- SERR- NoISA- VGA- MAbort- >Reset- FastB2B-
        PriDiscTmr- SecDiscTmr- DiscTmrStat- DiscTmrSERREn-
    Capabilities: [7f8 v1] Vendor Specific Information: ID=ffff Rev=1 Len=808 <?>
    Kernel driver in use: pcieport

\ Deleted lines ...
```

To identify the serial number, do

```
# lspci -s 9:0.0 -v | grep -E "Subsystem|Serial"
    Capabilities: [a4] Subsystem: Dolphin Interconnect Solutions AS Device 0940
    Capabilities: [100] Device Serial Number 00-00-43-43-00-00-00-0a
```

This shows the card as revision 0x4343 (hexadecimal values of the 'CC' letters in the ASCII table), with the production number 0x0000000A (0000010 in decimal).

## Support

More information about the product, support and software download can be found at <http://www.dolphinics.com>.

For general support questions, please contact Dolphin via the Jira Service Management portal:

<https://www.dolphinics.com/csp>.



## Technical Information

### Board revision history

The following table gives a general overview of the hardware revision history.

Adapter card revision	Capabilities
MXH940-AA	<ul style="list-style-type: none"> <li>Initial prototype, only support for FireFly™ v1</li> <li>PM40052</li> </ul>
MXH94x-BB /MH95x-BB	<ul style="list-style-type: none"> <li>Support for FireFly™ V2.</li> <li>PM40052</li> <li>Current version.</li> </ul>
MXH940-CC /MH95x-CC	Same as MXH940-BB, optimized for volume manufacturing. <ul style="list-style-type: none"> <li>PM40036</li> <li>Current version.</li> </ul>
MXH940-CD /MH95x-CD	Same as MXH940-CC but using a PM40052 configured as a PM40036 due to part availability. No changes to form, fit and function. Unused stations in the PM40052 are disabled. Same power consumption. PCI Device ID is still 0x4036 <ul style="list-style-type: none"> <li>Current version.</li> </ul>

Please reference the MXH94x\_MH95x\_PCN for details.

### Simplified schematics

The figure below shows the adapter card simplified schematics. Only the main functions are shown. Number and type of FireFly™ 's mounted depends on the product variant.

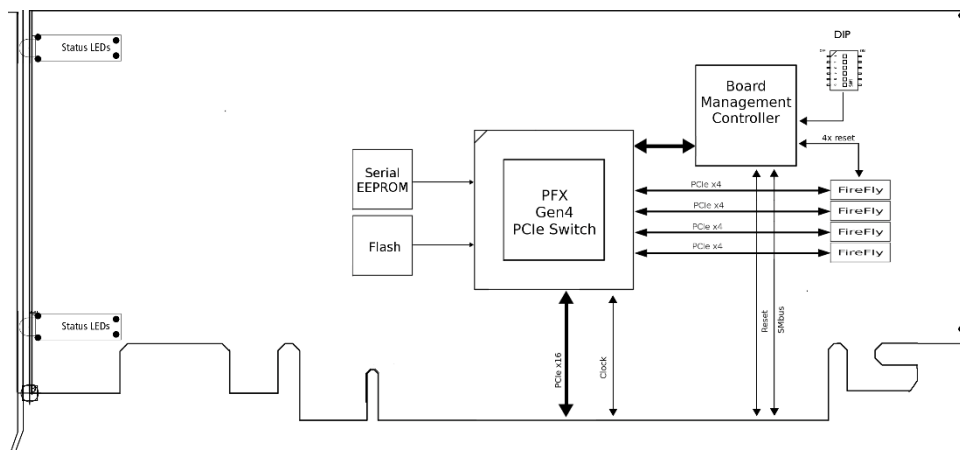

Figure 2: Adapter card simplified schematics

## Compliance and Regulatory Testing

### EMC Compliance

The adapter has been tested to the following relevant test standards for PCI Express cards, telecommunication and industry equipment installed in a standard PC:

EN 55032:2015 + A11:2020  
EN 55035:2017  
EN 61000-3-2:2014  
EN 61000-3-3:2013  
47 CFR Part 15. Subpart B (Clause 15.107 and 15.109) in conjunction with ANSI C63.4:2014  
CISPR 32:2015 / KS C 9832:2019  
CISPR 35:2017 / KS C 9835:2019



This does not ensure that it will comply with these standards in any random PC. It is the responsibility of the integrator to ensure that their products are compliant with all regulations where their product will be used.

### FCC Class A

This equipment is tested and found to comply with the limits for a Class A digital device, pursuant to part 15 of the FCC Rules.



### RoHS Compliance

The adapter card is RoHS compliant. A Compliance certificate issued by the manufacturer is available upon request.



### Laser Eye Safety

The MXH94x and MXH5x series are classified as a Class 1 laser.

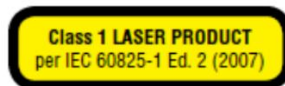

Complies with FDA performance standards for laser products except for deviations pursuant to Laser Notice No. 50, dated June 24, 2007.

Caution – Use of controls or adjustment or performance of procedures other than those specified herein may result in hazardous radiation exposure.

### WEEE Notice

The adapter card is labelled in accordance with European Directive 2002/96/EC concerning waste electrical and electronic equipment (WEEE). The Directive determines the framework for the return and recycling of used appliances as applicable throughout the European Union. This label is applied to products to indicate that the product is not to be thrown away but returned to your local approved WEEE waste collector.



## Limited Warranty

Dolphin Interconnect Solutions warrants this product to be free from manufacturing defects under the following terms:

### Warranty Period

The warranty applies for one (1) year from the date of purchase. Extended warranty is available.

### Coverage

To the extent permitted by applicable law, this warranty does not apply to:

- Damage caused by operator error or non-compliance with instructions available for the product.
- Use or attempt to use or program firmware not approved by Dolphin.
- Damage due to accidents, abuse, misuse, improper handling or installation, moisture, corrosive environments, high voltage surges, shipping, or abnormal working conditions.
- Damage caused by acts of nature, e.g. floods, storms, fire, or earthquakes.
- Damage caused by any power source out of range or not provided with the product.
- Normal wear and tear.
- Attempts to repair, modify, open, or upgrade the product by personnel or agents not authorized by Dolphin.
- Products for which the serial number label has been tampered with or removed.
- Damage to the product caused by products not supplied by Dolphin.

### Service Procedure

If the product proves defective during the Warranty Period, you should contact the seller that supplied you with the product, or if you purchased it directly from Dolphin, email [returnrequests@dolphinics.com](mailto:returnrequests@dolphinics.com) to obtain a valid RMA number and instructions. Products returned to Dolphin without a proper RMA number will not be serviced under this warranty.