



Dolphin PCI Express IXH610

Adapter card users guide

Version 1.13

Date: 30th November 2023

Table of contents

Table of contents	2
DISCLAIMER.....	3
Quick install guide.....	4
IXH610 operating modes	4
Cable connections.....	5
Overview.....	6
Dolphin Express adapter card - IXH610	7
IXH610 high level specification.....	7
LEDs.....	8
Use cases	8
Use case A: Transparent IO.....	8
Use case B - 2 Node configuration - NTB mode (unbalanced)	8
Use case C - 2 Node Configuration – NTB Mode (Balanced)	9
Use case D - Switch configuration	9
Use case E – Downstream target.....	10
Configuration and DIP-switches	11
DIP switch bank SW 1 - SWMODE.....	12
DIP switch bank SW 2 – configuration.....	13
Use cases summary and settings	14
Installation	15
Changing the PCI Express bracket.....	15
Installing the adapter card.....	15
Installing and removing the cable.....	15
EEPROM Programming.....	15
Software installation	16
Identifying the card.....	16
Support.....	17
Technical information.....	18
Compliance and regulatory testing.....	20
EMC compliance.....	20
RoHS compliance	20
Flammability standard	20
Limited warranty.....	21
Warranty Period.....	Error! Bookmark not defined.
Coverage	Error! Bookmark not defined.
Service procedure.....	Error! Bookmark not defined.
Limitations	21

DISCLAIMER

DOLPHIN INTERCONNECT SOLUTIONS RESERVES THE RIGHT TO MAKE CHANGES WITHOUT FURTHER NOTICE TO ANY OF ITS PRODUCTS TO IMPROVE RELIABILITY, FUNCTION, OR DESIGN. DOLPHIN INTERCONNECT SOLUTIONS DOES NOT ASSUME ANY LIABILITY ARISING OUT OF THE APPLICATION OR USE OF ANY PRODUCT.

LIFE SUPPORT POLICY

DOLPHIN INTERCONNECT SOLUTIONS' PRODUCTS ARE NOT AUTHORIZED FOR USE AS CRITICAL COMPONENTS IN LIFE SUPPORT DEVICES.

ENVIRONMENTAL POLICY

Dolphin is minimizing the amount of printed documentation and software CDs in its shipments, please download additional documentation and software from www.dolphinics.com/support.

Quick install guide

The IXH610 can be installed in any compliant PCI Express x8 or x16, Gen1, Gen2 or Gen3 slot. The IXH610 does not support slot sizes less than an x8 slot.

Note: *Static electricity from your clothes or work environment can damage your PCI Express adapter card or your PC. Always wear a grounded antistatic wrist strap while opening the PC and when the card is removed from the anti-static bag.*

IXH610 operating modes

The Dolphin PCI Express IXH610 card has two main operational modes, transparent and NTB mode. The mode is controlled by the BOOT EEPROM SELECT DIP-switch labeled SW2 that can be found close to the upper edge of the board. The two mode configuration options are found in the table below. DIP-switch position 1 controls setting the board in transparent or non-transparent mode (NTB). The DIP-switch can be seen on the picture below.

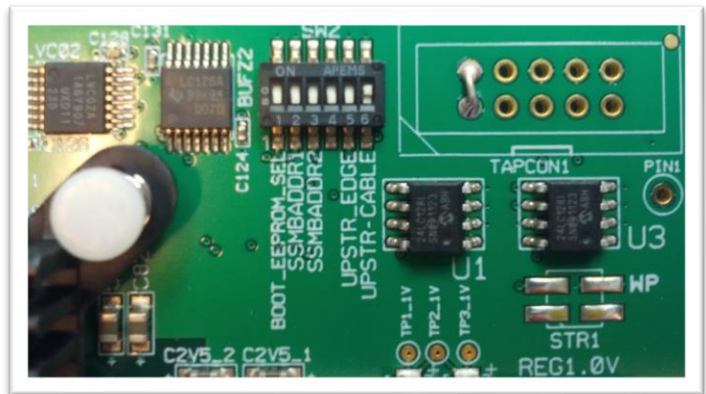

Picture 1: DIP Switch SW2 location



Setting	SW2 DIP view	Configuration
ON		Transparent mode
OFF		NTB mode

Table 1: Main configuration settings, BOOT EEPROM Select, SW2

All other DIP switches should normally be left in the factory default setting. More details on DIP-switch settings can be found on page 10 in this document.

Cable connections

The IXH610 requires a x8 iPass™ or PCI Express standard cable. A single x8 cable is used to connect to other devices including transparent I/O devices, another PC with an IXH610 or IXH620 card, or an IXS600 8 port switch.



Picture 2: iPass connector on IXH610

To install the cable, match the male portion on the x8 cable with the female connector on the IXH610 board. Use even pressure to insert the connector until it is secure. Adhere to ESD guidelines when installing the cable ensure not to damage the board. The IXH610 supports both copper and active fiber cables.

The Dolphin Express IXH610 adapter card is compliant with Dolphins extensive software package for the IXH adapter card and the IDT Demo software. Please visit <http://www.dolphinics.com/support> to download the latest documentation and software. Dolphin provides software and documentation for several product families; please remember to select the IX product family before downloading.

Overview

This document describes the new Dolphin PCI Express IX interconnect family and the IXH610 PCI Express Gen2 adapter card. The card is based on the PES24NT6G2 PCI Express Gen2 chipset from IDT. The IX product family consists of the following products:

- IXH610 PCI Express Gen2 x8 Host adapter card
- IXH611 PCI Express Gen2 x8 Host and Target adapter card
- IXH620 XMC PCI Express Gen2 Host and Target adapter card
- IXS600 8 port PCI Express Gen3 rack mount switch
- IXE60X PCI Express expansion products (contact Dolphin for details)

Information on the cabling infrastructure is available at http://www.dolphinics.com/products/IX_PCI_Express_cables.html

The IXH610 adapter can be used to connect to any of the above products or to any compliant existing PCI Express downstream device having a standard PCI Express x8 connector (PCI Express Gen 1 or Gen2, auto detect).

All Dolphin PCI Express IXH adapters support the complete suite of Dolphin NTB Software including Dolphin SuperSockets™, optimized TCP/IP drivers, and SISCI Embedded software. It is also compliant with the PXImc software specification.

Dolphin SuperSockets is a Berkeley compliant Sockets library which provides socket latency below 2 microseconds and close to the wire speed streaming bandwidth for networked applications. SuperSockets™ is currently available on Linux and Windows. It is a 100% transparent plug and play solution for commercial and embedded applications. More on SuperSockets can be found at <http://www.dolphinics.com/products/dolphin-supersockets.html>

Dolphin's optimized TCP/IP driver enables PCI Express to be used as a traditional 10G Ethernet / 40G Ethernet replacement for e.g. NFS sharing and legacy networking that does not need the low latency provided by SuperSockets. The TCP/IP driver supports gateway functionality.

The SISCI software provides well defined, easy to use shared memory programming API for PCI Express over cable. More on SISCI can be found at <http://www.dolphinics.com/products/embedded-sisci-developers-kit.html>

More information about the software provided for the Dolphin IXH adapter cards can be found on <http://www.dolphinics.com/products>.

Dolphin Express adapter card - IXH610

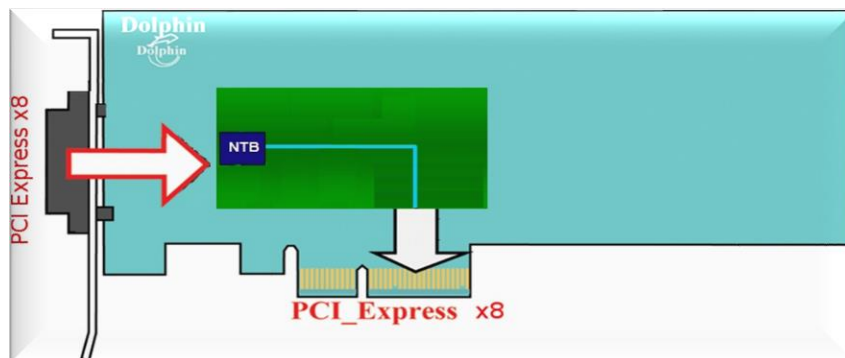

Illustration 1: Low profile, single PCI Express Gen2 x8 HBA

The IXH610 is a PCI Express Gen2 x8 adapter card available from Dolphin providing an easy to use, multi functional solution.

IXH610 high level specification

- PCI Express Gen2 5.0 Gbps per lane signaling– 40 Gbps total signaling.
- PCI Express Gen2 x8 edge connector. The card installs in any PCI Express slot that has a physical x8 or x16 connector.
- Compliant with PCI Express Gen1 and Gen3 computers and IO systems, auto detection.
- Supports NTB connections to other hosts and transparent connections to IO systems as a transparent P2P device.
- PCI Express Base Specification Rev 2.1
- PCI Express External Cabling Specification, Rev. 1.0
- One PCI Express Gen2 x8 IPASS Cable connection.
- Copper cables tested successfully up to 7 meters.
- Support for Active Optical Fibers, up to 300 meters.
- Low Profile - PCI Express Electromechanical Specification, Rev 2.0
- Comes with both low profile and standard profile PCI Express bracket.
- PIO and Direct DMA capabilities
- Host clock isolation. Automatic support for host running CFC or SSC mode.
- Support for hot plugging of the PCI Express cable (NTB mode, SISCI and SuperSockets)
- Dual 128 KB EEPROM for boot up configuration data.
- Optional Software utility for reprogramming of EEPROM content.
- No PCI Express power domain isolation.
- Full SuperSockets and SISCI compliance via new PAL. Linux and Windows support.
- SMBus support.
- Power Consumption: 3,3 Volt - Max 7 Watt.
- Operating temperature 0°C to 55°C
- Relative Humidity 5% - 95% non-condensing
- Weight: 80 Gram
- JTAG programming and test
- RoHS compliant
- Compliant to EN-55022, EN 55024-A1&A2, EN 61000-6-2
- CE Mark

LEDs

The IXH610 cards has two bi-color LEDs visible through the PCI Express front bracket.

LED Name	Dark	Yellow	Green	Green - blinking
Link	Power off or failure	Power on, Link down	Power on, Link Up	Power on, Link active, data transmitted
NTB	Transparent Host mode	NA	NTB mode (PXImc/SISCI/SuperSockets/TCP/IP mode)	NA

Table 2: LED overview

The NTB link LED is controlled by software. Both LEDs depend on GPIO registers initialized by EEPROM. An incorrect EEPROM can cause dark LEDs. DIP-switch SWMODE set to 0000b will cause all LEDs to be dark. More details on DIP-switch settings can be found below.

Use cases

The IXH610 card may be used in the following use cases. The use cases are summarized in Table 3 Adapter use cases on page 10.

Use case A: Transparent IO

The Dolphin IXH610 HCA connects to any standardized PCI Express x8 downstream device. No special device driver is required for the IXH610 card. Any device in the PCI Express IO system will operate using its standard device driver.

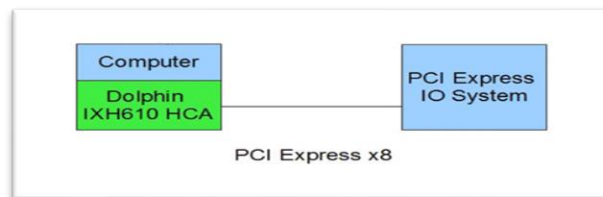

Illustration 2: IXH610 used to connect to a remote PCI Express IO System

Use case B - 2 Node configuration - NTB mode (unbalanced)

2 node unbalanced “NTB” mode- The Dolphin PCI Express IXH610 adapter connects to a remote upstream subsystem (with root complex) that may have a transparent re-driver card only. This configuration is not supported by Dolphin software.

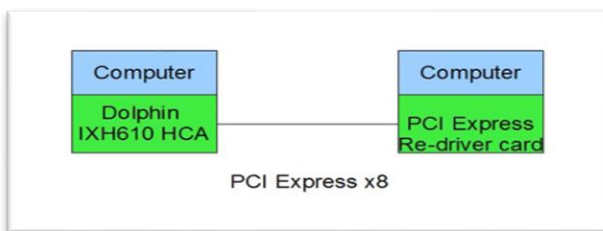

Illustration 3: Adapter card used to connect to a remote host using a re-driver card.

Use case C - 2 Node Configuration – NTB Mode (Balanced)

Each node has a Dolphin PCI Express IXH610 adapter or Dolphin Express IXH620 XMC adapter direct connection to remote host using a PCI Express Gen2 x8 cable. This configuration is fully supported by all Dolphin software.



Illustration 4: Adapter card used to build a two node configuration.

Use case D - Switch configuration

Each node has a Dolphin Express IXH610 adapter or Dolphin Express IXH620 XMC. Up to 8 systems can be connected to the Dolphin IXS600 8 port PCI Express Gen2 switch.

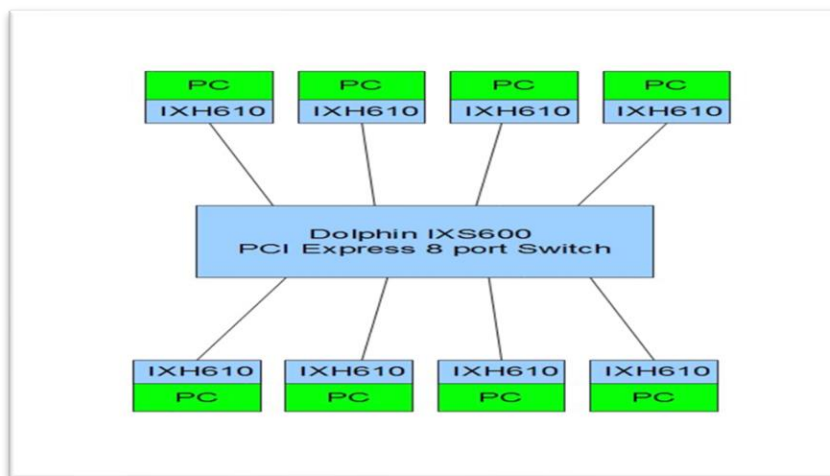

Illustration 4: Switch use

Use case E – Downstream target

The IXH620 XMC adapter or IXH611 PCIe adapter can be used as a downstream target adapter.

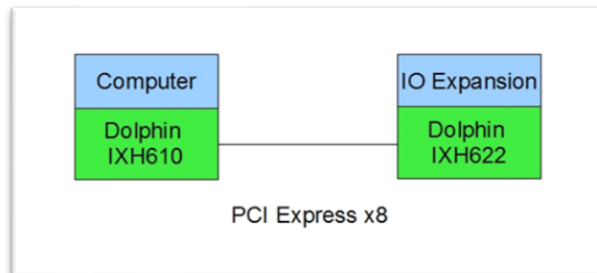

Illustration 5: IXS620 as target mode

Configuration and DIP-switches

The IXH610 has two banks of DIP switches. The locations of the DIP switches on the cards are shown as SW1 and SW2 on figure 5 below. The Default factory setting is NTB configuration (see Use case C - 2 Node Configuration – NTB Mode (Balanced) and Use case D - Switch configuration, All Dolphin Software using default setting). The IXH610 will also support transparent use, upstream mode (see Use case A: Transparent IO).

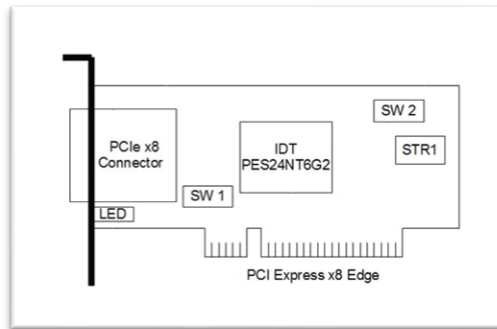

Illustration 6 : IXH610 overview

The IXH610 has DIP-switches for setting special modes or operations. Please carefully read the documentation before modifying any DIP-switch settings. Please carefully pay attention to ON and OFF positions written on the DIP switch.

DIP switch bank SW 1 - SWMODE



Picture 3: DIP Switch SW1 location

This DIP should normally be kept in factory default mode. These DIP switches are used to directly control the PES24NT6G2 Software MODE. Please refer to the PES24NT6G2 data sheet for details. The most useful options are documented in the table below.

Binary value – SWMODE [3:0]	Description
0000b	Single partition, no EEPROM configuration. Supports default transparent configuration – non optimized settings. No LEDs operational. This setting can be used as an emergency setting if an incorrect or corrupted EEPROM content prevents the system from booting. Supports reprogramming of the EEPROM.
1100b	Default setting. Configuration data in EEPROM.



Illustration 7: SW1 – SWMODE - Default setting

DIP switch bank SW 2 - configuration

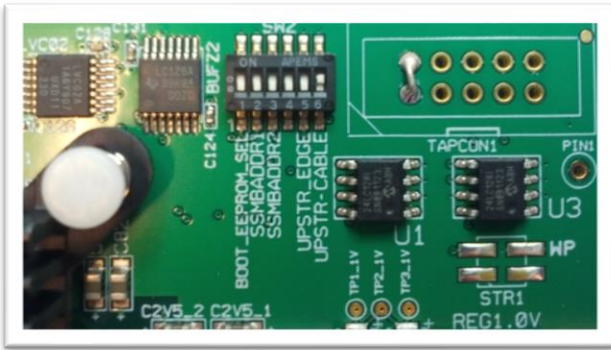

This DIP Switch is used to configure transparent and non-transparent modes, set the SMBus address and select the clock source.

Picture 4: DIP Switch SW2 location

DIP no	Name	Description	ON	OFF	Default
1	Boot EEPROM Select	Used to select EEPROM 1 or 2 as boot image.	Load configuration from EEPROM 2 Factory default is TRANSPARENT Host mode	Load configuration from EEPROM 1 Factory default is NTB mode	Off
2 and 3	SMBus address	Sets the SMBus address to which the slave SMBus interface responds.			Off
4	Not used				Off
5	Upstream edge select				off
6	Upstream cable select	Used to select clock source and propagate RESET	Adapter card drives CREFCLK, CRST on cable if adapter is upstream.	Local clock mode, no CRST on cable	on

Note: Some DIP switch configuration options may be removed in the future versions. Please always consult the user guide for details.

Use cases summary and settings

The table below gives an overview of the various use cases, settings and limitations. SW2 DIP switch settings not mentioned should be OFF

Use case	Description	SW2 DIP-switch setting	Clock source	Cable pull	Power Sequence requirements	Software / Driver
A	Downstream – Dolphin adapter card connects to downstream IO	BOOT_EEPROM select ON UPSTREAM_CABLE ON	Adapter card received REFCLK from host Adapter card drives CREFLK on cable	Not supported by legacy device drivers	IO system must power on first	No driver required for IXH610 card. Legacy drivers for IO Devices
B	“NTB” Dolphin adapter card connects to remote re-driver card	BOOT_EEPROM select OFF UPSTREAM_CABLE OFF	Adapter card receives clock from PCI Express cable	Special solution needed for re-driver card side. OS need to support hot removal.	System with IXH610 adapter card need to power on first	
C	Dolphin Host – Host. Both connected systems has Dolphin adapter card.	BOOT EEPROM select OFF UPSTREAM_CABLE ON	Both cards runs on local clock	Fully supported	No limitations	Dolphin SISI, SuperSockets, TCP/IP, PXImc
D	Dolphin Switch configuration. All connected hosts have Dolphin adapter card	BOOT_EEPROM select OFF UPSTREAM_CABLE ON	Adapter card transmits clock on PCI Express cable	Fully supported	No limitations	Dolphin SISI, SuperSockets, TCP/IP, PXImc
E	Downstream target – Requires an IXH611 or IXH620 adapter.	BOOT_EEPROM select ON UPSTREAM_EDGE ON UPSTREAM_CABLE OFF	Adapter card receives CRECLK from cable Adapter card received REFCLK from expansion unit	Not supported by legacy device drivers	IO system must power on first	No driver required for IXH610 card. Legacy drivers for IO Devices

Table 3: Adapter use cases

Installation

Static electricity from your clothes or work environment can damage your PCI Express adapter card or your PC. Always wear a grounded antistatic wrist strap while opening the PC and when the IXH610 is removed from the anti-static bag.

Changing the PCI Express bracket

The IXH610 package includes a standard and low-profile PCI Express bracket. By default, the standard height bracket is installed on the board. If you need to replace the mounted bracket with a low-profile bracket, carefully unscrew the two mounting screws to remove the full height bracket. Save the two mounting screws and replace the bracket with the low-profile bracket. Use the two mounting screws to install the low-profile bracket. The screws should be carefully tightened. Be careful not to overtighten.

Installing the adapter card

Before installing the adapter card, make sure you are properly grounded to avoid static discharges that may destroy your computer or the adapter card. Ensure you are properly grounded before opening your computer or the anti-static bag containing the IXH610. Please follow your computer's manual on how to install a PCI Express card.

The IXH610 Adapter card can be installed into any PCI Express x8 or x16 slot. The IXH610 supports both PCI Express Gen2 and Gen1 signaling. *NOTE: A Gen2 slot is recommended as it typically doubles the performance compared to a Gen1 slot.* The IXH610 is a x8 card so no additional performance can be obtained using an x16 slot. The IXH610 can be installed in a PCI Express Gen3 slot but will operate at Gen2 speed.

The IXH610 supports both hosts using spread spectrum and constant frequency clocking. The card implements clock isolation and will provide a high quality CREFCLK signal on the cable. Refer to the DIP switch settings for configuration information.

Installing and removing the cable

The IXH610 supports PCI Express x8 Gen2 cables. Installing and removing cables should be done with both upstream and downstream devices powered off. The Dolphin SuperSockets, TCP/IP drivers and SISI fully support hot plugging (*Note: installation and removal*) of cables while the system is running). Standard PCI Express cables are not designed for a high number of installations and removals; the gold applied to the connector head may wear out and cause loss of communication. Please contact your Dolphin if you intend to continuously connect and disconnect the PCI Express cables.

Connecting the cable

Please carefully install the PCI Express cable connector into the connector housing on the IXH610 adapter card or IXS600 Switch box. Computer cables should always use strain relief to protect the connected equipment from excessive force via the cable. This is especially important for cables between racks.

Disconnecting the cable

Please carefully pull back the thumb tab to release the cable from the connector house and pull back the cable.

EEPROM Programming

Dolphin may from time to time publish updated firmware. Current firmware is normally included in the Dolphin software distribution and published on www.dolphinics.com/support. Please consult the software documentation for information on firmware upgrades or Dolphin support if assistance is required.

Software installation

More information on installing Dolphins SuperSockets, SISCO or TCP/IP driver software can be found at <http://www.dolphinics.com/support/installation-ix.html>

Identifying the card

The card has a label-sticker with the serial number in the format 'IXHXXX-YY-ZZZZZZ', where XXX denotes the card-type (e.g. 610), YY denotes the card revision (e.g. DE) and ZZZZZZ denotes the serialized production number (e.g. 012345) – this whole string makes up the serial number of the card (i.e. IXH610-DE-012345).

With the DIS software installed and loaded, you can get this serial number with the ixdiag command.

The top of this output will show information about the card:

```
Adapter 0 > Type                : IXH610
             NodeId              : 4
             Serial number       : IXH610-DE-001352
             IXH chipId          : 0x8091111d
             IXH chip revision   : 0x00000002 (ZC)
             EEPROM version NTB mode : 0024
             EEPROM version transp mode : 0009
             EEPROM swmode[3:0]   : 1100
             EEPROM images       : 0001
             Card revision       : DE
```

Here you will see both the whole serial-number string, as well as the decoded card-type and card-revision identifiers. The 'EEPROM version NTB mode' may be of interest – this shows the firmware-version of the card.

You can also get this information without ixdiag (for instance when the drivers are not loaded or the card is in transparent mode), using lspci in Linux;

First run lspci and identify the card. It will show up as something like

```
02:00.0 PCI bridge: Integrated Device Technology, Inc. Device 8091 (rev 02)
02:00.1 Bridge: Integrated Device Technology, Inc. Device 8091 (rev 02)
02:00.2 System peripheral: Integrated Device Technology, Inc. Device 8091 (rev 02)
```

Second, do an `lspci -vvv -s <device>`, and look for the 'Serial' -string

```
# lspci -s 02:00.0 -vvv | grep Serial
Capabilities: [180 v1] Device Serial Number 00-00-44-45-00-00-05-48
```

This shows the card as revision 0x4445 (hexadecimal values of the 'DE' letters in the ASCII table), with the production number 0x00000548 (001352 in decimal).

In Windows, we export the serial number through the event-log through the transparent-mode driver is loaded (v 1.0.1 or later required). This driver is available through the download-section at http://www.dolphinics.com/support/index_support_ix.html

```
PS C:\> Get-EventLog System -Source IXH_T -Newest 1
```

Index	Time	EntryType	Source	InstanceID	Message
34206	Oct 25 23:02	Information	IXH_T	1074069505	Serial number is IXH610-CC-000101.

Support

More information about the product, support and software download can be found at <http://www.dolphinics.com>.

For general support questions, please contact Dolphin via the Jira Service Management portal:

<https://www.dolphinics.com/csp>.

Technical information

PCI-Express 8x finger connector pin-out

Pin	Side B Connector		Side A Connector	
	Name	Description	Name	Description
1	+12v	+12 volt power	PRSNT#1	Hot plug presence detect
2	+12v	+12 volt power	+12v	+12 volt power
3	RSVD	Reserved	+12v	+12 volt power
4	GND	Ground	GND	Ground
5	SMCLK	SMBus clock	JTAG2	TCK
6	SMDAT	SMBus data	JTAG3	TDI
7	GND	Ground	JTAG4	TDO
8	+3.3v	+3.3 volt power	JTAG5	TMS
9	JTAG1	+TRST#	+3.3v	+3.3 volt power
10	+3.3V	3.3v volt power	+3.3v	+3.3 volt power
11	WAKE#	Link Reactivation	PWRGD	Power Good
Mechanical Key				
12	RSVD	Reserved	GND	Ground
13	GND	Ground	REFCLK+	Reference Clock Differential pair
14	PETp(0)	Transmitter Lane 0, Differential pair	REFCLK-	
15	PETn(0)		GND	Ground
16	GND	Ground	PERp(0)	Receiver Lane 0, Differential pair
17	PRSNT#2	Hotplug detect	PERn(0)	
18	GND	Ground	GND	Ground
19	PETp(1)	Transmitter Lane 1, Differential pair	RSVD	Reserved
20	PETn(1)		GND	Ground
21	GND	Ground	PERp(1)	Receiver Lane 1, Differential pair
22	GND	Ground	PERn(1)	
23	PETp(2)	Transmitter Lane 2, Differential pair	GND	Ground
24	PETn(2)		GND	Ground
25	GND	Ground	PERp(2)	Receiver Lane 2, Differential pair
26	GND	Ground	PERn(2)	
27	PETp(3)	Transmitter Lane 3, Differential pair	GND	Ground
28	PETn(3)		GND	Ground
29	GND	Ground	PERp(3)	Receiver Lane 3, Differential pair
30	RSVD	Reserved	PERn(3)	
31	PRSNT#2	Hot plug detect	GND	Ground
32	GND	Ground	RSVD	Reserved
33	PETp(4)	Transmitter Lane 4, Differential pair	RSVD	Reserved
34	PETn(4)		GND	Ground
35	GND	Ground	PERp(4)	Receiver Lane 4, Differential pair
36	GND	Ground	PERn(4)	
37	PETp(5)	Transmitter Lane 5, Differential pair	GND	Ground
38	PETn(5)		GND	Ground
39	GND	Ground	PERp(5)	Receiver Lane 5, Differential pair
40	GND	Ground	PERn(5)	
41	PETp(6)	Transmitter Lane 6, Differential pair	GND	Ground
42	PETn(6)		GND	Ground
43	GND	Ground	PERp(6)	Receiver Lane 6, Differential pair
44	GND	Ground	PERn(6)	
45	PETp(7)	Transmitter Lane 7, Differential pair	GND	Ground
46	PETn(7)		GND	Ground
47	GND	Ground	PERp(7)	Receiver Lane 7, Differential pair
48	PRSNT#2	Hot plug detect	PERn(7)	
49	GND	Ground	GND	Ground

PCIe iPass cable connector pin-out

PIN#	Row A signal name	Row B signal name
1	GND	GND
2	PETp(0)	PERp(0)
3	PETn(0)	PERn(0)
4	GND	GND
5	PETp(1)	PERp(1)
6	PETn(1)	PERn(1)
7	GND	GND
8	PETp(2)	PERp(2)
9	PETn(2)	PERn(2)
10	GND	GND
11	PETp(3)	PERp(3)
12	PETn(3)	PERn(3)
13	GND	GND
14	CREFCLOCK+	+3,3V POWER
15	CREFCLOCK-	+3,3V POWER
16	GND	+3,3V POWER
17	RESERVED	POWER RET
18	RESERVED	POWER RET
19	SIDEBAND RETURN	POWER RET
20	CPRESNT#	CWAKE# ¹
21	CPWRON	CPERST#
22	GND	GND
23	PET(p4)	PERp(4)
24	PET(n4)	PERn(4)
25	GND	GND
26	PET(p5)	PERp(5)
27	PET(n5)	PERn(5)
28	GND	GND
29	PETp(6)	PERp(6)
30	PETn(6)	PERn(6)
31	GND	GND
32	PETp(7)	PERp(7)
33	PETn(7)	PERn(7)
34	GND	GND

¹ CWAKE is optional and not used on IXH610
IXH610 Users Guide – Dolphin Interconnect Solutions

Compliance and regulatory testing

EMC compliance

The Dolphin PCI Express IXH610 adapter has been tested and found to comply with the following relevant test standards for PCI Express cards, Telecommunication and Industry equipments installed in a standard PC:



EN 55022 (2010)
EN 55024 (1998) + A1 (2001) + A2 (2003)
EN 61000-6-2 (2005)

This does not ensure that it will comply with these standards in any random PC. It is the responsibility of the integrator to ensure that their products are compliant with all regulations where their product will be used.

RoHS compliance

The Dolphin IXH610 is RoHS compliant. A compliance certificate issued by the Manufacturer is available upon request.



Flammability standard

The Dolphin IXH610 PWB is UL94V-0 compliant. The board has the 94V-0 mark in its silk screen.

WEEE Notice

This IXH610 is labelled in accordance with European Directive 2002/96/EC concerning waste electrical and electronic equipment (WEEE). The Directive determines the frame work for the return and recycling of used appliances as applicable throughout the European Union. This label is applied to various products to indicate that the product is not to be thrown away, but returned to your local approved WEEE waste collector.



Limited warranty

Dolphin Interconnect Solutions warrants this product to be free from manufacturing defects under the following terms:

Warranty Period

The warranty applies for one (1) year from the date of purchase. Extended warranty is available.

Coverage

To the extent permitted by applicable law, this warranty does not apply to:

- Damage caused by operator error or non-compliance with instructions available for the product.
- Use or attempt to use or program firmware not approved by Dolphin.
- Damage due to accidents, abuse, misuse, improper handling or installation, moisture, corrosive environments, high voltage surges, shipping, or abnormal working conditions.
- Damage caused by acts of nature, e.g. floods, storms, fire, or earthquakes.
- Damage caused by any power source out of range or not provided with the product.
- Normal wear and tear.
- Attempts to repair, modify, open, or upgrade the product by personnel or agents not authorized by Dolphin.
- Products for which the serial number label has been tampered with or removed.
- Damage to the product caused by products not supplied by Dolphin.

Service Procedure

In the event that the product proves defective during the Warranty Period, you should contact the seller that supplied you with the product, or if you purchased it directly from Dolphin, visit <https://www.dolphinics.com/csp> to obtain a valid RMA number and instructions. Products returned to Dolphin without a proper RMA number will not be serviced under this warranty.

Limitations

TO THE FULLEST EXTENT PERMITTED BY LAW, DOLPHIN WILL NOT BE LIABLE FOR ANY INDIRECT, INCIDENTAL, SPECIAL OR CONSEQUENTIAL DAMAGES (INCLUDING LOST PROFITS, LOST DATA, OR LOSS OF USE) ARISING OUT OF ANY USE DOLPHIN'S PRODUCTS, SOFTWARE OR SERVICE PROVIDED. DOLPHIN'S MAXIMUM LIABILITY WILL NOT EXCEED THE TOTAL AMOUNT PAID FOR THE PRODUCT BY PURCHASER.